

Scope of Performance LVS (R)

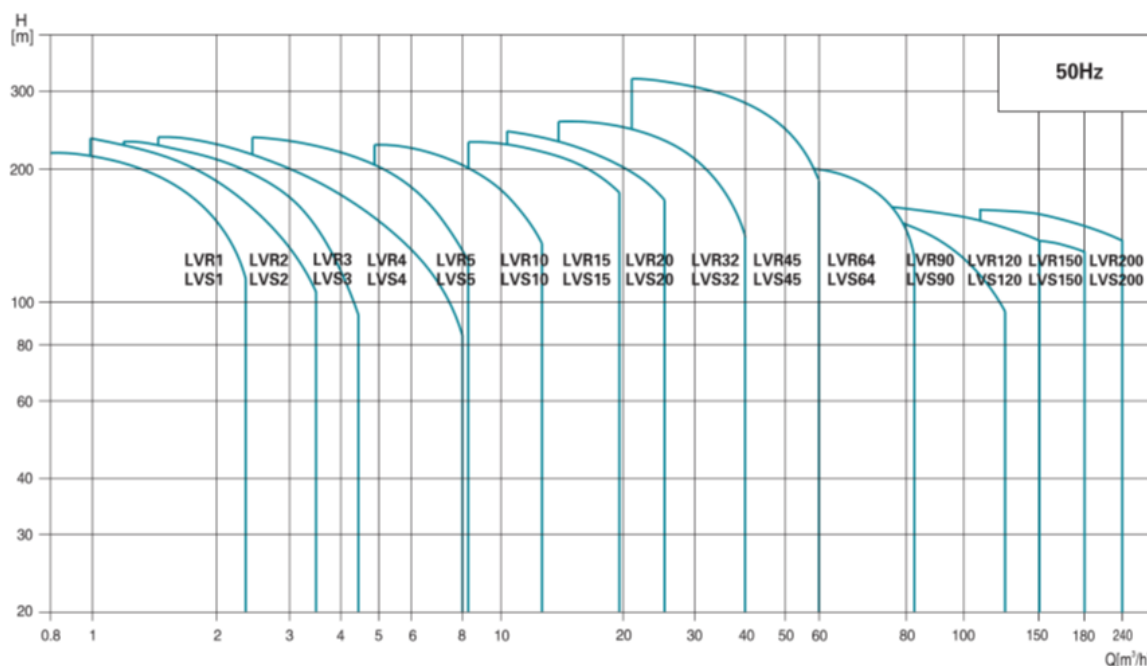

Product Range

MODEL	LVR(S)1	LVR(S)2	LVR(S)3	LVR(S)4	LVR(S)5	LVR(S)10	LVR(S)15	LVR(S)20	LVR(S)32	LVR(S)45	LVR(S)64	LVR(S)90	LVR(S)120	LVR(S)150	LVR(S)200
DESCRIPTION	LVR(S)1	LVR(S)2	LVR(S)3	LVR(S)4	LVR(S)5	LVR(S)10	LVR(S)15	LVR(S)20	LVR(S)32	LVR(S)45	LVR(S)64	LVR(S)90	LVR(S)120	LVR(S)150	LVR(S)200
Rated flow [m³/h]	1	2	3	4	5	10	15	20	32	45	64	90	120	150	200
Flow range [m³/h]	0.7-2.4	1.0-3.5	1.2-4.5	1.5-8	2.5-8.5	5-13	8-23	10.5-29	15-40	22-58	30-85	45-120	60-150	80-180	100-240
Max. pressure [bar]	22	23	24	21	24	22	23	25	28	33	22	20	16	16	16
Motor power [kW]	0.37-2.2	0.37-3	0.37-3	0.37-4	0.37-4	1.1-7.5	1.1-15	1.1-18.5	1.5-30	3-45	4-45	5.5-45	11-75	11-75	18.5-110
Temperature Range [°C]	-20°C--+120°C (Note: Both the Max. permissible pressure and liquid temperature range refer to the pump capacity.)														
Max. pump efficiency [%]	45	46	55	59	60	65	70	72	78	79	80	81	74	73	79
Pipe connection-LVR															
Oval flange	G1	G1	G1	G1 1/4	G1 1/4	-	-	-	-	-	-	-	-	-	-
DIN flange	DN25	DN25	DN25	DN32	DN32	DN40	DN50	DN50	DN65	DN80	DN100	DN100	DN125	DN125	DN150
Pipe connection-LVS															
Oval flange	-	-	-	-	-	-	-	-	-	-	-	-	-	-	-
DIN flange	DN32	DN32	DN32	DN32	DN32	DN40	DN50	DN50	DN65	DN80	DN100	DN100	DN125	DN125	DN150
Clamp connector	φ42	φ42	φ42	φ42	φ42	-	-	-	-	-	-	-	-	-	-
Threaded connector	R ₂ 1 1/4	R ₂ 1 1/4	R ₂ 1 1/4	R ₂ 1 1/4	R ₂ 1 1/4	-	-	-	-	-	-	-	-	-	-

Ambient Temperature

An ambient temperature of over 40 ° C or an installation at an altitude above 1000 meters above sea level requires an oversized motor. Due to low air density and poor cooling, the output power P_2 decreases, as shown in the table below:

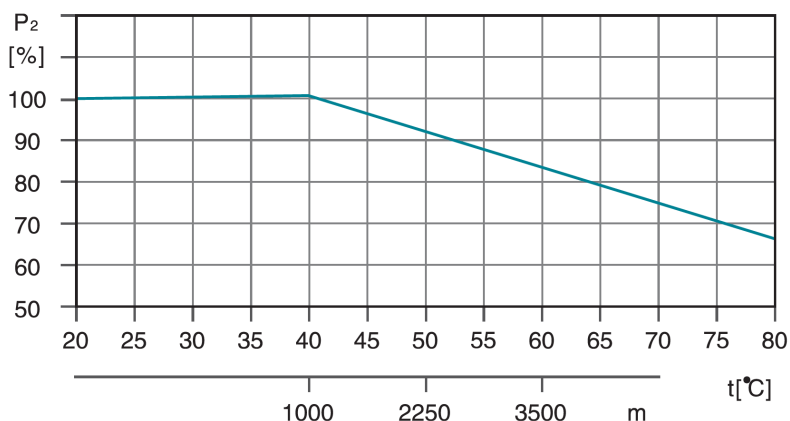

For example, when the pump is installed at an altitude of 3500 meters, P_2 will decrease by 88%. And when the ambient temperature is 70 ° C, P_2 will decrease by 78%.

Maximum Operation pressure (bar)

The table below shows the maximum discharge pressures of the various LVS (R) pumps. The suction pressure of the pump + the set pressure must always be lower than the maximum operating pressure of the pump. If the maximum working pressure is exceeded, it can damage the motor bearings and reduce the service life of the mechanical seal.

Model	LVR Max. Operation pressure [bar]		LVS Max. Operation pressure [bar]
	Oval Flange	DIN Flange	
LVR (S) 1	16	25	25
LVR (S) 2	16	25	25
LVR (S) 3	16	25	25
LVR (S) 4	16	25	25
LVR (S) 5	16	25	25
LVR (S) 10		25	25
LVR (S) 15		25	25
LVR (S) 20		25	25
LVR (S) 32-1-1 - 32-7	16		16
LVR (S) 32-8-2 - 32-14	30		30
LVR (S) 45-1-1 - 45-5	16		16
LVR (S) 45-6-2 - 45-11	30		30
LVR (S) 45-12-2 - 45-13-2	33		33
LVR (S) 64-1-1 - 64-5	16		16
LVR (S) 64-6-2 - 64-8-1	30		30
LVR (S) 90-1-1 - 90-4	16		16
LVR (S) 90-5-2 - 90-6	30		30
LVR (S) 120-1 - 120-7	20		20
LVR (S) 150-1-1 - 150-6	20		20
LVR (S) 200-1-D - 200-4	20		20

Minimum Inlet Pressure–Npsh

Calculation of the inlet pressure “H” is recommended in these situations:

- The liquid temperature is high.
- The flow is significantly higher than the rated flow.
- Water is drawn from depths.
- Water is drawn through long pipes.
- Inlet conditions are poor.

To avoid cavitation, make sure that there is a minimum pressure on the suction side of the pump. The maximum suction lift “H” in meters head can be calculated as follows:

H	= $P_b \times 10.2 - NPSH - H_f - H_v - H_s$
P_b	= Barometric pressure in bar. (Barometric pressure can be set to 1 bar). In closed systems, P_b indicates the system pressure in bar.
NPSH	= Net Positive Suction Head in meters head. (To be read from the NPSH curve at the highest flow the pump will be delivering.)
H_f	= Friction loss in suction pipe in meters head. (At the highest flow the pump will be delivering.)
H_v	= Vapor pressure in meters head. (To be read from the vapor pressure scale. “ H_v ” depends on the liquid temperature “ t_m ”)
H_s	= Safety margin = minimum 0.5 meters head.

If the “H” calculated is positive, the pump can operate at a suction lift of maximum “H” meters head.
 If the “H” calculated is negative, an inlet pressure of minimum “H” meters head is required.

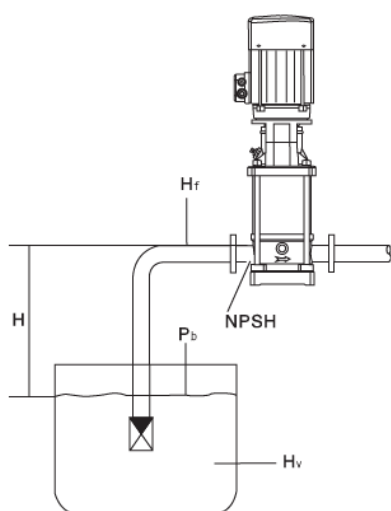

t_m [°C]	H_v [m]
190	126
180	100
170	79
160	62
150	45
140	40
140	35
130	30
130	25
120	20
110	15
100	12
100	10
90	8.0
90	6.0
80	5.0
80	4.0
70	3.0
60	2.0
50	1.5
50	1.0
40	0.8
40	0.6
30	0.4
30	0.3
20	0.2
10	0.1
0	0

Note: To avoid cavitation, never select a pump with a duty point too far to the right on the NPSH curve. Always check the NPSH value of the pump at the highest possible flow.

LVR5 vertical multistage stainless steel in line pump



LVR

Application

- Transfer of liquids with low viscosity, non-flammable and non-explosive, not containing solid particles or fibers. These liquids must not chemically attack the materials of the pump.
- Water supply for tall buildings, pumping stations, overpressure
- Washing stations, heating water circulation, air conditioning water circulation, water treatment systems
- Distillation systems, municipal swimming pools
- Irrigation: sprinkling, drip
- Industry
- Fire fighting systems

Pompe

- Liquid temperature: from -20°C to +120°C
- Nominal flow: 5 m³/h
- maximum pressure: 24 bars
- pH between 4 and 10

Moteur

- IE3 motor
- Protection class: IP55
- Maximum ambient temperature: +40°

Identification codes

LVR m 5 -10 -B /F(A, K, G)

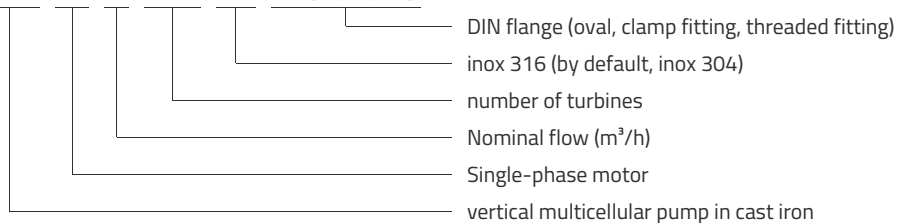

Technical data

MODEL	kW	Q (m ³ /h)	1	2	3	4	5	6	7	8	8.5
		Q (l/min)	17	33	50	67	83	100	117	133	142
LVRm5-2	0.37		13	12	12	10	9	7	6		
LVR5-2	0.37		13	12	12	10	9	7	6		
LVRm5-3	0.55		19	19	18	16	15	12	10		
LVR5-3	0.55		19	19	18	16	15	12	10		
LVRm5-4	0.55		26	25	24	22	19	16	14		
LVR5-4	0.55		26	25	24	22	19	16	14		
LVRm5-5	0.75		33	32	30	28	24	22	18		
LVR5-5	0.75		33	32	30	28	24	22	18		
LVRm5-6	1.1		40	38	37	34	28	27	23		
LVR5-6	1.1		40	38	37	34	28	27	23		
LVRm5-7	1.1		46	45	42	40	32	32	27		
LVR5-7	1.1		46	45	42	40	32	32	27		
LVRm5-8	1.1		53	51	48	45	40	36	31		
LVR5-8	1.1		53	51	48	45	40	36	31		
LVRm5-9	1.5		60	59	56	53	47	44	37		
LVR5-9	1.5		60	59	56	53	47	44	37		
LVRm5-10	1.5		67	65	62	59	53	48	41		
LVR5-10	1.5		67	65	62	59	53	48	41		
LVRm5-11	2.2		74	73	70	66	59	54	47		
LVR5-11	2.2		74	73	70	66	59	54	47		
LVRm5-12	2.2		81	79	76	72	63	59	51		
LVR5-12	2.2		81	79	76	72	63	59	51		
LVRm5-13	2.2		88	85	82	78	68	64	55		
LVR5-13	2.2		88	85	82	78	68	64	55		
LVRm5-14	2.2		95	92	89	83	74	69	60		
LVR5-14	2.2		95	92	89	83	74	69	60		
LVRm5-15	2.2		101	99	95	89	79	74	63		
LVR5-15	2.2		101	99	95	89	79	74	63		
LVRm5-16	2.2		108	105	101	95	85	78	68		
LVR5-16	2.2		108	105	101	95	85	78	68		
LVRm5-18	3		122	119	115	109	98	90	78		
LVR5-18	3		122	119	115	109	98	90	78		
LVRm5-20	3		135	132	127	120	108	100	87		
LVR5-20	3		135	132	127	120	108	100	87		
LVR5-22	4		150	147	142	134	120	112	97		
LVR5-24	4		163	160	154	146	132	122	106		
LVR5-26	4		176	173	166	157	145	132	115		
LVR5-29	4		198	194	188	178	155	149	131		
LVR5-36	5.5		244	237	231	218	205	185	163	136	120

Hydraulic performance

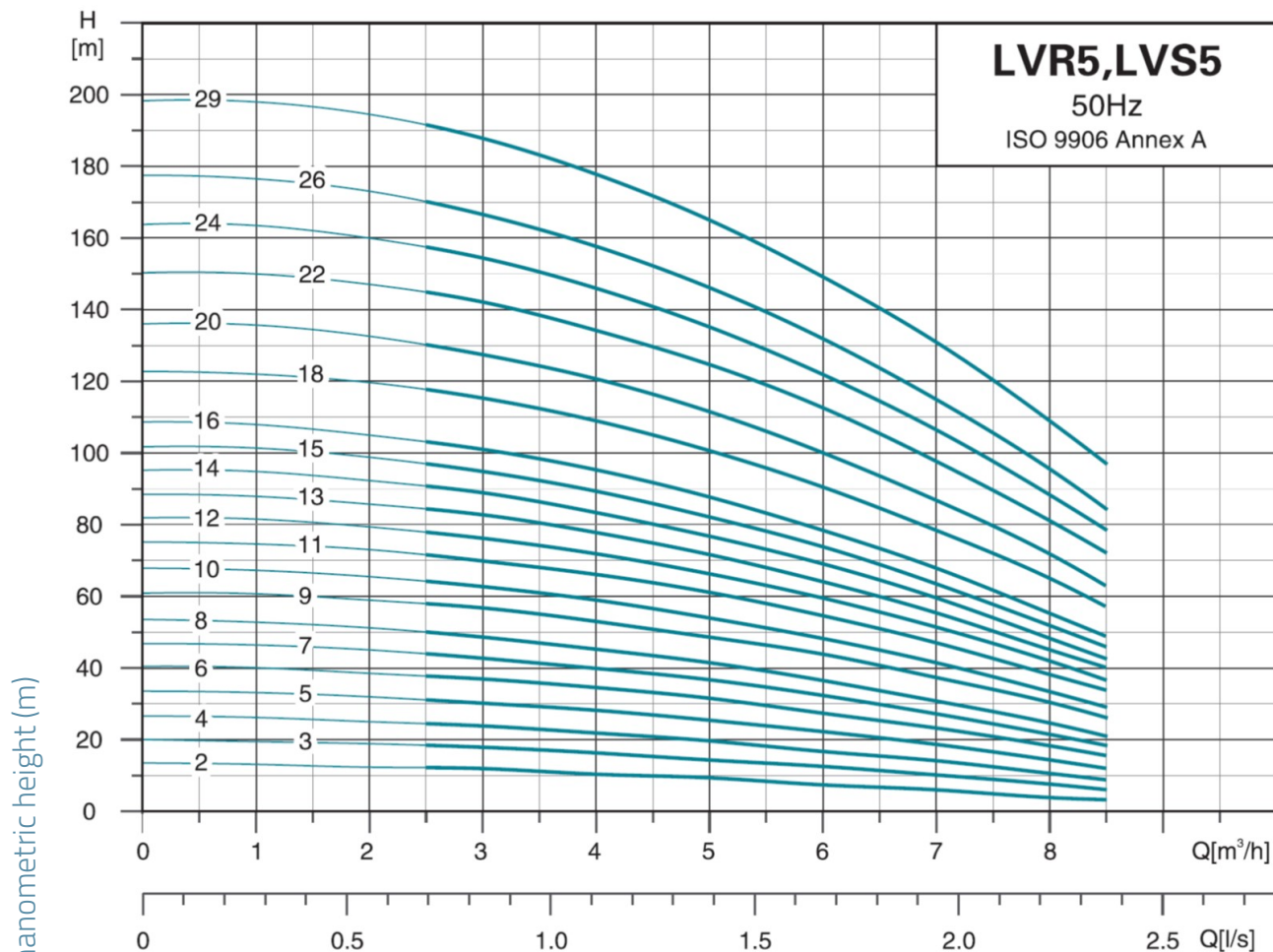

Total manometric height (m)

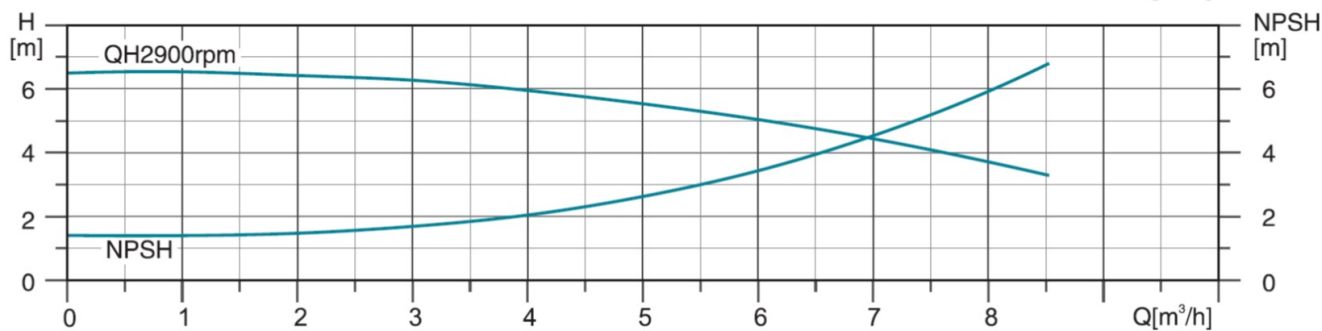
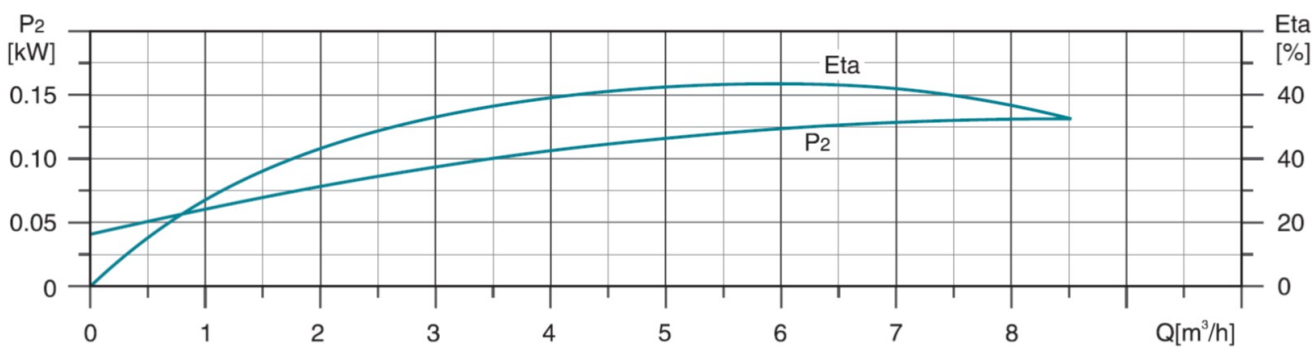

Dimensions

MODEL	B1/bride-ovale	B1+B2/bride-ovale	B1/bride-DIN	B1+B2/bride-DIN	D1	D2	poids
LVRm5-2	256	470	282	496	130	105	20.9
LVR5-2	256	470	282	496	130	105	20.9
LVRm5-3	283	497	309	523	130	105	21.8
LVR5-3	283	497	309	523	130	105	21.8
LVRm5-4	310	524	336	550	130	105	22.7
LVR5-4	310	524	336	550	130	105	22.7
LVRm5-5	341	609	367	635	150	125	25.5
LVR5-5	341	609	367	635	150	125	25.5
LVRm5-6	368	636	394	662	150	125	27.6
LVR5-6	368	636	394	662	150	125	27.6
LVRm5-7	395	663	421	689	150	125	28.5
LVR5-7	395	663	421	689	150	125	28.5
LVRm5-8	422	690	448	716	150	125	29.1
LVR5-8	422	690	448	716	150	125	29.1
LVRm5-9	465	783	491	809	164	127	37.3
LVR5-9	465	783	491	809	164	127	37.3
LVRm5-10	492	810	518	836	164	127	37.9
LVR5-10	492	810	518	836	164	127	37.9
LVRm5-11	519	837	545	863	164	127	39.4
LVR5-11	519	837	545	863	164	127	39.4
LVRm5-12	546	864	572	890	164	127	39.9
LVR5-12	546	864	572	890	164	127	39.9
LVRm5-13	573	891	599	917	164	127	40.5
LVR5-13	573	891	599	917	164	127	40.5
LVRm5-14	600	918	626	944	164	127	40.9
LVR5-14	600	918	626	944	164	127	40.9
LVRm5-15	627	945	653	971	164	127	41.5
LVR5-15	627	945	653	971	164	127	41.5
LVRm5-16	654	972	680	998	164	127	42.4
LVR5-16	654	972	680	998	164	127	42.4
LVRm5-18	712	1052	738	1078	186	120	49.9
LVR5-18	712	1052	738	1078	186	120	49.9
LVRm5-20	766	1106	792	1132	186	120	51.3
LVR5-20	766	1106	792	1132	186	120	51.3
LVR5-22	820	1160	846	1186	186	120	54.2
LVR5-24	874	1214	900	1240	186	120	55.5
LVR5-26	928	1268	954	1294	186	120	58.2
LVR5-29	1009	1349	1035	1375	186	120	59.9
LVR5-36			1249	1648	210	142	

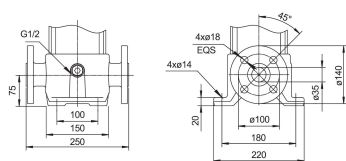
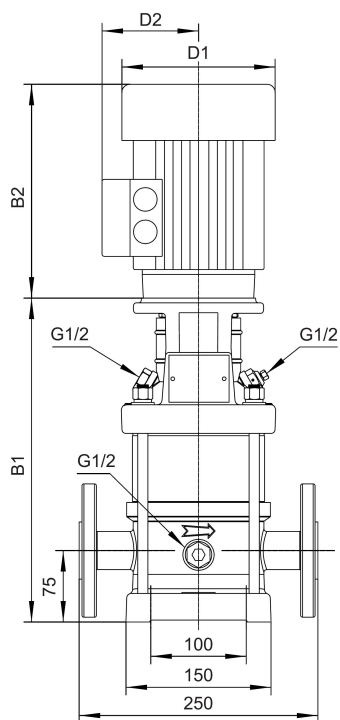

Brides LVR5

Options

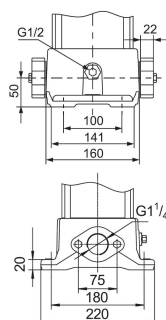

Oval flange (A)

No.	Type	Materials
1	Lower water box	cast iron HT200
2	Drain plug	AISI 304 stainless steel
3	Diffuser	AISI 304 stainless steel
4	Diffuser with bearing	AISI 304 stainless steel
5	Intermediate diffuser	AISI 304 stainless steel
6	Impeller	AISI 304 stainless steel
7	Final scroll	AISI 304 stainless steel
8	Lantern	cast iron HT200
9	Filling plug	AISI 304 stainless steel
10	Coupling	
11	Engine	
12	Coupling protection housing	AISI 304 stainless steel
13	Cartridge mechanical seal	
14	Drain plug	AISI 304 stainless steel
15	Pump shaft	AISI 304 stainless steel
16	Jacket	AISI 304 stainless steel
17	Flange	cast iron HT200

